



2024

**Sineklik Sistemleri Alüminyum Profil Katalođu**  
Fly Screen Systems Aluminium Profile Catalogue

# ALÜMİNYUM PROFİL GRUBU

Aluminium Profile Group

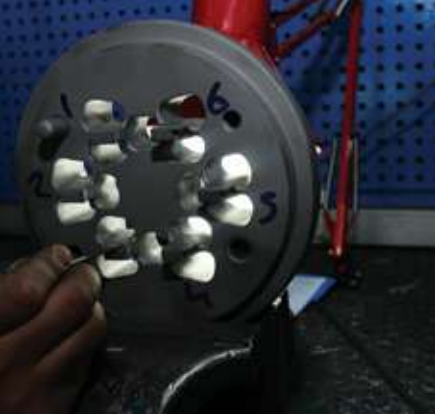

ISO 9001 | ISO 14001 | OHSAS 18001

## GOLD SERİ PLİSE SİNEKLİK / GOLD SERIES PLAİT FLY SCREEN

304

0,318 kg/m

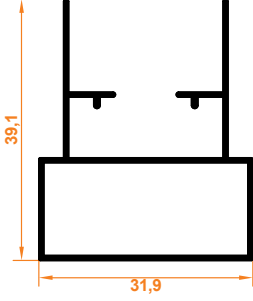

Gold Kasa Profil  
Gold Case Profile

305

0,330 kg/m

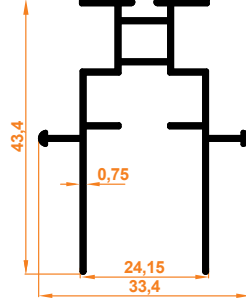

Gold Kanat Profil  
Gold Wing Profile

## STAR SERİ PLİSE SİNEKLİK / STAR SERIES PLAİT FLY SCREEN

302

0,272 kg/m

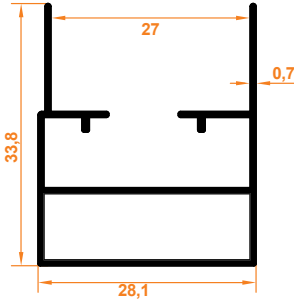

Star Kasa Profil  
Star Case Profile

301

0,303 kg/m

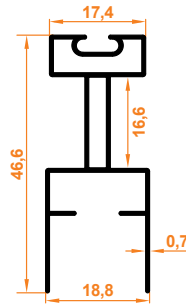

Star Kanat Profil  
Star Wing Profile

## JUNIOR SERİ PLİSE SİNEKLİK / JUNIOR SERIES PLAİT FLY SCREEN

306

0,243 kg/m

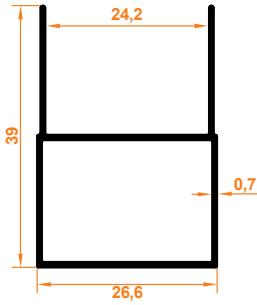

Junior Kasa Profil  
Junior Case Profile

307

0,304 kg/m

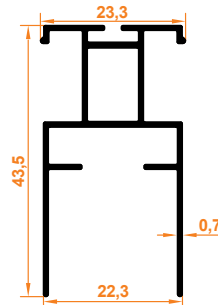

Junior Kanat Profil  
Junior Wing Profile

345

0,162 kg/m

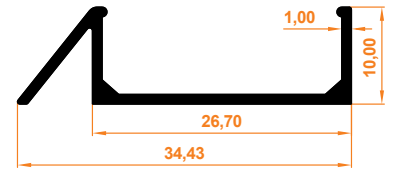

Junior Eşiksiz Kasa Profil  
Junior Case Profile without Threshold

**SLIM SERİ PLİSE SİNEKLİK / SLIM SERIES PLAİT FLY SCREEN**

**300** 0,218 kg/m

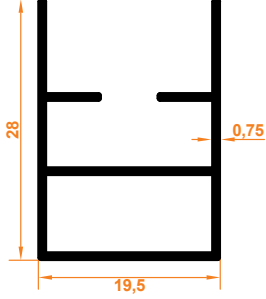

**Slim Kasa Profili**  
Slim Case Profile

**301** 0,303 kg/m

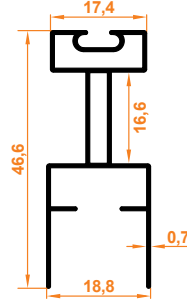

**Slim Kanat Profili**  
Slim Wing Profile

**331** 0,168 kg/m



**Slim Eşiksiz Profili**  
Slim Profile without Threshold

**NOBEL SERİ PLİSE SİNEKLİK / NOBEL SERIES PLAİT FLY SCREEN**

**335** 0,345 kg/m

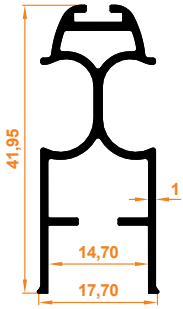

**Nobel Kanat Profili**  
Nobel Wing Profile

**336** 0,148 kg/m

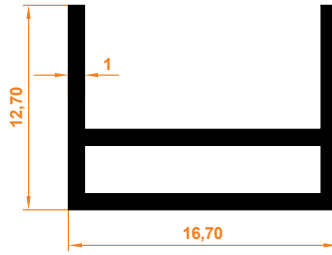

**Nobel Eşiksiz Kasa Profili**  
Nobel Case Profile without Threshold

**338** 0,250 kg/m

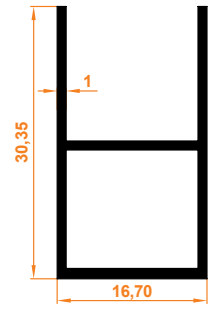

**Nobel Kasa Profili**  
Nobel Case Profile

**SÜPER SERİ PLİSE SİNEKLİK / SUPER SERIES PLAİT FLY SCREEN**

**316** 0,248 kg/m

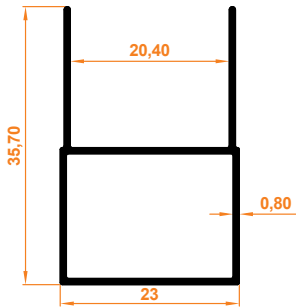

**Süper Seri Kasa Profili**  
Super Case Profile

**320** 0,303 kg/m

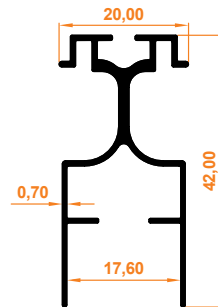

**Süper Seri Kanat Profili**  
Super Wing Profile

**325** 0,469 kg/m

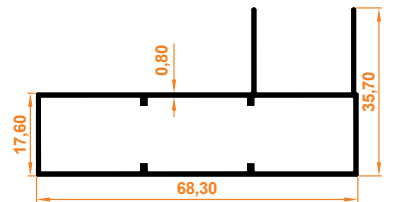

**Süper Büyük Kasa Profili**  
Super Big Case Profile

## NOBEL SERİ İÇTEN MONTAJLI PLİSE SİNEKLİK / NOBEL SERIES INTERNAL MOUNTED PLAIT FLY SCREEN

337

0,338 kg/m

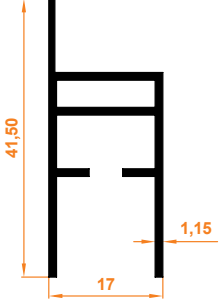

Nobel İçten Montajlı Kasa Profili  
Nobel Internal Mounted Case Profile

335

0,345 kg/m

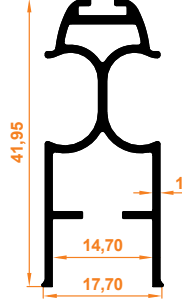

Nobel Kanat Profili  
Nobel Wing Profile

## SLIM SERİ İÇTEN MONTAJLI PLİSE SİNEKLİK / SLIM SERIES INTERNAL MOUNTED PLAIT FLY SCREEN

317

0,272 kg/m

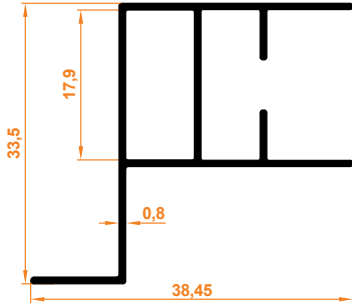

Kasa Profil  
Case Profile

301

0,303 kg/m

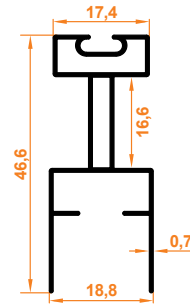

Kanat Profil  
Wing Profile

## İÇTEN MONTAJLI SABİT SİNEKLİK / INTERNAL MOUNTED FIXED FLY SCREEN

405

0,256 kg/m

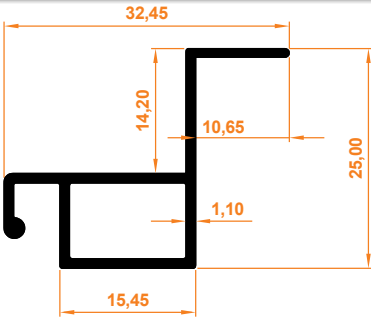

Kasa Profili  
Case Profile



**AYKİM SERİ SİNEKLİK / AYKİM SERIES FLY SCREEN**

**309** 0,374 kg/m

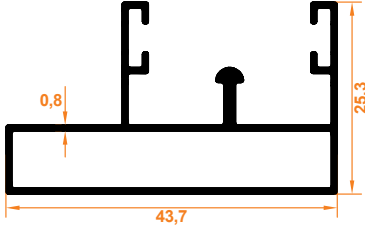

**Aykim Kasa Profil**  
Aykim Case Profile

**310** 0,315 kg/m

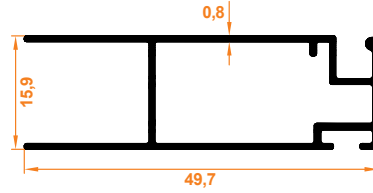

**Aykim Hareketli Profil**  
Aykim Sliding Profile

**PLATİN SERİ SİNEKLİK / PLATİN SERIES FLY SCREEN**

**321** 0,352 kg/m

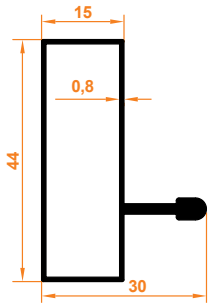

**Platin Tekli Kasa Profil**  
Platin Single Case Profile

**322** 0,455 kg/m

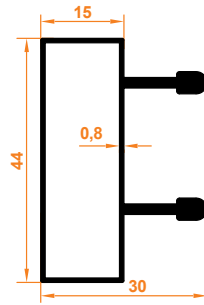

**Platin Çiftli Kasa Profil**  
Platin Double Case Profile

**323** 0,506 kg/m

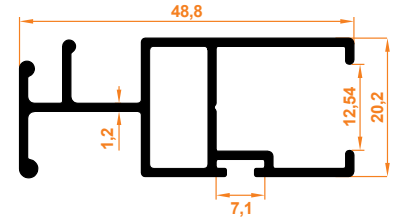

**Platin Kanat Profil**  
Platin Wing Profile

**DÜZ SİNEKLİK PROFİL GRUBU**  
Flat Fly Screen Profile Group

**400** 0,105 kg/m

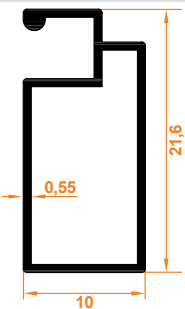

**10x20 Sineklik**  
10x20 Fly Screen

**401** 0,142 kg/m

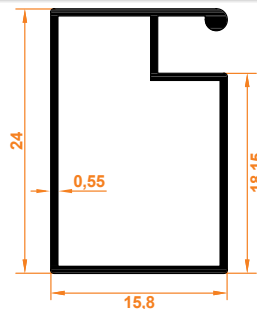

**17x25 Sineklik**  
17x25 Fly Screen

**402** 0,250 kg/m

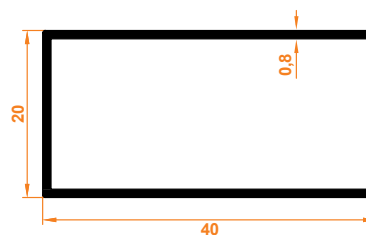

**20x40 Sineklik**  
20x40 Fly Screen

**311** 0,304 kg/m

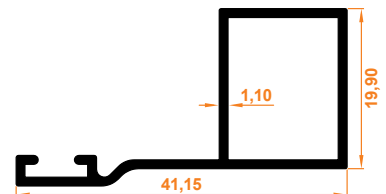

**İçe Açılır Fitilli Sineklik Profili**  
Inward Foldable Flyscreen Profile

# STOR SİNEKLİK PROFİL GRUBU

Stor Fly Screen Profile Group



407

0,342 kg/m

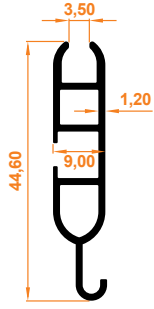

Stor Kanat Profil  
Stor Wing Profile

408

0,286 kg/m

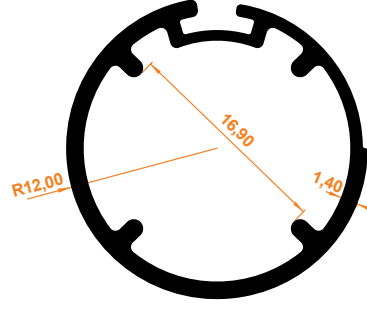

Stor Boru Profil  
Stor Pipe Profile

409

0,526 kg/m

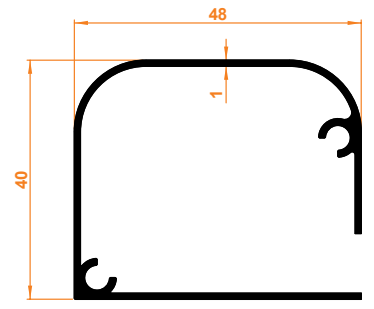

Stor Kasa Profil  
Stor Case Profile

410

0,413 kg/m

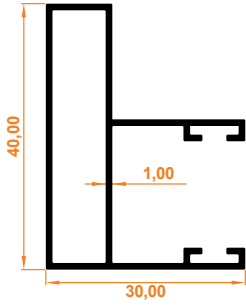

Stor Yan Kasa Profil  
Stor Side Case Profile

411

0,318 kg/m

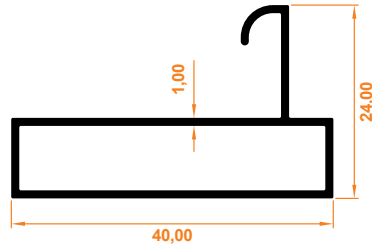

Stor Alt Kasa Profil  
Stor Bottom Case Profile

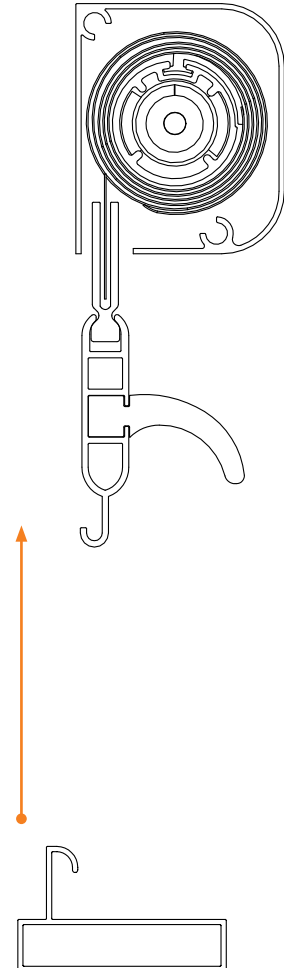
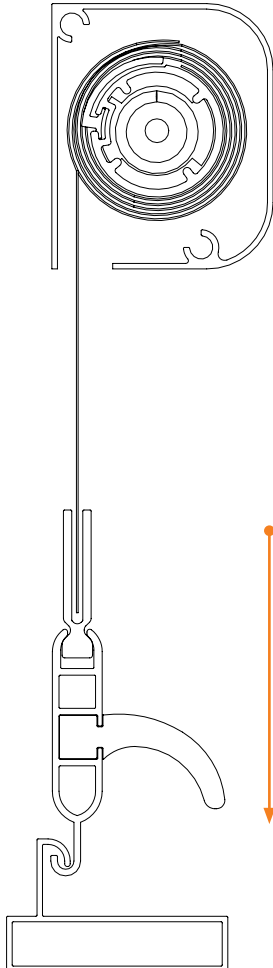



 demarco  panjurmen  prosin  process plise

 Process Alüminyum Plastik San. Tic. Ltd. Şti.

#### MERKEZ

Aşağıpınarbaşı OSB Mah. 524 Nolu Sk. No: 3/1  
42250, Selçuklu-Konya/TÜRKİYE

T : +90 332 248 00 92

F : +90 332 248 00 93

M : info@process.com.tr

#### MARMARA BÖLGE MÜDÜRLÜĞÜ

Cihangir Mh. Talatpaşa Cad. No:67  
Avcılar/İSTANBUL - TÜRKİYE

T : +90 212 407 17 42

F : +90 212 407 15 42

M : marmara@process.com.tr



|| [www.demarco.com.tr](http://www.demarco.com.tr)

|| [www.processplise.com.tr](http://www.processplise.com.tr)

|| [www.panjurmen.com.tr](http://www.panjurmen.com.tr)

|| [www.prosin.com.tr](http://www.prosin.com.tr)

[www.process.com.tr](http://www.process.com.tr)